

This article was downloaded by:

On: 24 January 2011

Access details: *Access Details: Free Access*

Publisher *Taylor & Francis*

Informa Ltd Registered in England and Wales Registered Number: 1072954 Registered office: Mortimer House, 37-41 Mortimer Street, London W1T 3JH, UK



Journal of Macromolecular Science, Part A

Publication details, including instructions for authors and subscription information:

<http://www.informaworld.com/smpp/title~content=t713597274>

The Topochemistry of Acrylamide Polymerization in Inverse Suspension

M. Dimonie^a; N. Marinescu^a; D. S. Vasilescu^a; O. Shaffer^b; H. Caldararu^c; A. Caragheorghopol^c; J. Languri^c

^a Faculty of Industrial Chemistry, Polytechnic Institute, Bucharest, Romania ^b Emulsion Polymers Institute Lehigh University, Bethlehem, Pennsylvania ^c Institute of Physical Chemistry, Bucharest, Romania

To cite this Article Dimonie, M. , Marinescu, N. , Vasilescu, D. S. , Shaffer, O. , Caldararu, H. , Caragheorghopol, A. and Languri, J.(1992) 'The Topochemistry of Acrylamide Polymerization in Inverse Suspension', Journal of Macromolecular Science, Part A, 29: 3, 277 – 296

To link to this Article: DOI: 10.1080/00222339208052126

URL: <http://dx.doi.org/10.1080/00222339208052126>

PLEASE SCROLL DOWN FOR ARTICLE

Full terms and conditions of use: <http://www.informaworld.com/terms-and-conditions-of-access.pdf>

This article may be used for research, teaching and private study purposes. Any substantial or systematic reproduction, re-distribution, re-selling, loan or sub-licensing, systematic supply or distribution in any form to anyone is expressly forbidden.

The publisher does not give any warranty express or implied or make any representation that the contents will be complete or accurate or up to date. The accuracy of any instructions, formulae and drug doses should be independently verified with primary sources. The publisher shall not be liable for any loss, actions, claims, proceedings, demand or costs or damages whatsoever or howsoever caused arising directly or indirectly in connection with or arising out of the use of this material.

THE TOPOCHEMISTRY OF ACRYLAMIDE POLYMERIZATION IN INVERSE SUSPENSION

M. DIMONIE, N. MARINESCU, and D. S. VASILESCU

Faculty of Industrial Chemistry
Polytechnic Institute
Bucharest, Romania

O. SHAFFER

Emulsion Polymers Institute
Lehigh University
Bethlehem, Pennsylvania 18015

H. CALDARARU, A. CARAGHEORGHEOPOL, and J. LANGURI

Institute of Physical Chemistry
Bucharest, Romania

ABSTRACT

The acrylamide polymerization in inverse suspension has been studied for the cyclohexane-acrylamide-water system in the presence of an "oil"-soluble emulsifier [polyoxyethylene (4) nonylphenol, EO(4)NP] and a redox initiator ($\text{NaHSO}_3\text{-K}_2\text{S}_2\text{O}_8$). The molecular weight of polyacrylamide has been found to increase significantly in the presence of alkaline salts of some organic acids. This effect is supposed to occur by interaction of the salts with the ethylene oxide groups of the emulsifier, thus limiting the chain transfer reactions. Several methods (conductometry, viscosimetry, UV and ESR spectroscopy, scanning electron microscopy) have been used to characterize the gel phase formed by the initial mixture of components. The topochemistry changes during the reaction

show several distinct stages: coarse water-in-oil dispersion, concentrated oil-in-water emulsion, bicontinuous system, and coarse polymer/water dispersion in oil.

INTRODUCTION

In recent years, several studies regarding acrylamide polymerization and copolymerization by inverse emulsion [1–5] as well as polyacrylamide microemulsion [6–8] have been published. The interest raised by these procedures is due to the superior characteristics of polyacrylamide obtained by polymerization in a heterogeneous media, which, in turn, has numerous important technical applications.

In comparison with other procedures, acrylamide polymerization by inverse suspension has been less well investigated [9]. This process takes place with a high polymerization rate, reaches the maximum conversion, and results in a linear (gel-free) polyacrylamide characterized by a very high molecular weight (10^6 to 10^7). The rather low consumption of emulsifier, the very low amount of coagulum, as well as ease of recovery of the polymer from the reaction medium are important advantages of this type of polymerization. The porous structure of the resulting polymer beads favorably influences its water dissolution, as well as the chemical transformation of the polyacrylamide thus obtained [10].

Acrylamide polymerization by inverse suspension differs from the widely accepted classical model for suspension polymerization of vinyl monomers. The similarities between these two processes are conventional ones, and they concern mainly the shape and size of particles obtained at the end of the polymerization.

The purpose of this work is to elucidate some aspects of the topochemistry of acrylamide polymerization by inverse suspension.

The system investigated in this paper consisted of: acrylamide-water as the aqueous phase (*W*) and polyoxyethylene(4)nonylphenol-cyclohexane as the organic phase (*O*). A redox system (NaHSO_3 - $\text{K}_2\text{S}_2\text{O}_8$) was used as initiator, and sometimes various electrolytes were added to the aqueous phase.

The reaction mixture has a gel structure at the beginning of the polymerization process, and therefore, we studied the structure and the properties of the gel phase, which has the same composition as the reaction mixture, excluding the initiator.

EXPERIMENTAL

Materials

Polyoxyethylene(4)nonylphenol [EO(4)NP] was IGEPAL CO-430 (GAF Co). Ethoxylated stearine with 8EO groups was MYRJ 45 (Atlas Europol S.p.a.). Cyclohexane was dried on molecular sieves and then distilled. Acrylamide (AM; American Cyanamid Co.) was used without further purification. The initiators and electrolytes were analytical-grade reagents and used as received. The water was freshly distilled and deionized before use.

Polymerization Procedure

Inverse suspension polymerization of acrylamide takes place when a concentrated aqueous solution of acrylamide is dispersed in an organic phase which consists of aliphatic or cycloaliphatic hydrocarbon in which emulsifiers were dissolved. Oxygen, being a strong inhibitor, was carefully removed before introduction of the initiator. The polymerization procedure has been described elsewhere [9].

The polymerization preparations used consisted of 10–60% acrylamide in water (aqueous phase) and of 0.5–15% EO(4)NP in cyclohexane (organic phase). The aqueous phase volume fraction $[W/(W + O)]$ varied from 0.1 to 0.7. The $\text{NaHSO}_3\text{-K}_2\text{S}_2\text{O}_8$ redox system was used as initiator. The concentration of iron ions (catalyst for redox system) was rigorously controlled. Three distinct stages characterized the polymerization process.

Stage 1. During the addition of the aqueous solution of acrylamide by vigorous stirring into the organic phase, an unstable dispersion is formed, which readily separates as soon as the stirring is stopped.

Stage 2. The reaction begins when the aqueous solutions of the two components of the initiation system ($\text{NaHSO}_3\text{-K}_2\text{S}_2\text{O}_8$) are introduced. This is accompanied by an almost instantaneous change of the reaction medium, which becomes viscous, opaque, seemingly homogeneous (without an apparent tendency to separate), and exhibits optical anisotropy. In this stage the viscosity of the medium increases rapidly and the formed gel has the tendency to rise on the stirrer (Weissenberg effect). When the polymerization reaction was stopped immediately after the gel formation, the conversion was found to be less than 1%. Very small amounts of polymer are enough to transform the dispersion into a gel.

Stage 3. As the polymerization progresses, the gel expels the organic phase. Due to the stirring, the gel breaks up into 0.3 to 1.0-mm particles and the polymerization continues in these particles which are suspended in the expelled organic phase.

The gel phase formation is not tied to the polymerization reaction, and under well-defined conditions, this phenomenon may take place spontaneously. In the absence of any initiator, when the cycles of stirring and phase separation (30–60 s) without stirring are repeated several times, the entire mass suddenly increases its viscosity (Fig. 1) and changes into a translucent gel that displays optical anisotropy. The stirring mode is the parameter having a critical, and at the same time unusual, effect on the acrylamide gel formation. These gels are unstable and in time phase-separate.

Gel Phase Characterization

Separation of the acrylamide gels into two phases was carried out in sealed calibrated vials and kept at 25°. After complete separation the volume of the two phases was measured. Analysis of the aqueous and organic phases resulting after gel separation was carried out with the apparatus presented in Fig. 2.

The aqueous or the organic phase was introduced with a syringe into a vial (1), which contained a roll of absorbing paper (4), and the narrow tube (a) was then sealed off. After liquid nitrogen was poured into the Dewar vessel (3) and the vial (1) was immersed in liquid nitrogen, the system was evacuated to 10^{-3} torr, and the

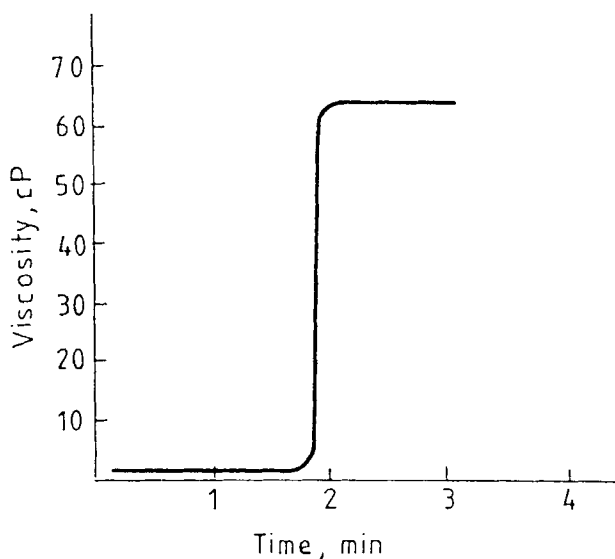

FIG. 1. Changes in viscosity of reaction mixture associated with gel formation; $W_i/(W_i + O_i) = 0.25$ $W_i = 1/1$ water/AM; $O_i = 3\%$ EO(4)NP in cyclohexane.

tube (b) was sealed off. Complete distillation of water and/or Cyclohexane from (1) to (2) was accomplished by cooling the latter in liquid nitrogen, while the rest of the apparatus was kept at room temperature. After the tube (c) was sealed, accurate volumetric measurements of the amount of water and/or cyclohexane in vial (2) were made. Traces of acrylamide, when present, were identified by chemical analysis.

In order to fractionate the acrylamide-emulsifier mixture in the vial (1), a heptane extraction was carried out. Absorption of aqueous phase on filter paper is necessary to avoid excessive foaming during distillation.

The UV-VIS measurements on the diffusion of UV markers in the acrylamide gels were carried out using a SPECORD 23 (Carl Zeiss Jena) spectrophotometer. Diffusion tests were done as follows: solid anthracene (organic-phase soluble marker) or solid Stralex (Scheme 1) (aqueous-phase soluble marker) is placed on the bottom of the UV cell.

The distance from the cell bottom to the light spot was approximately 10 mm. The gel to be investigated was carefully introduced in the cell to prevent mixing with the markers. UV spectra were recorded every 5 min, following the variation in time of the characteristic peaks.

ESR measurements were carried out using the following spin probes: N_1 [N,N,N -triethyl- N -(3-methylene-2,2,5,5-tetra-methyl-4-piperidinol-1-oxyl)-ammonium bromide] (Scheme 2), N_2 [2,2,6,6-tetramethyl-4 piperidinol-1-oxyl-dodecanoate] (Scheme 3) synthesized as previously reported [11], and N_3 [5-doxyl stearic acid] (Sigma Chemical Co.) (Scheme 4).

The nitroxides N_1 and N_2 (10^{-4} M) were introduced into the samples in one of following ways: either dissolved in the corresponding phase (N_1 in aqueous phase, N_2 in organic phase) prior to mixing of the two phases and gel formation or by

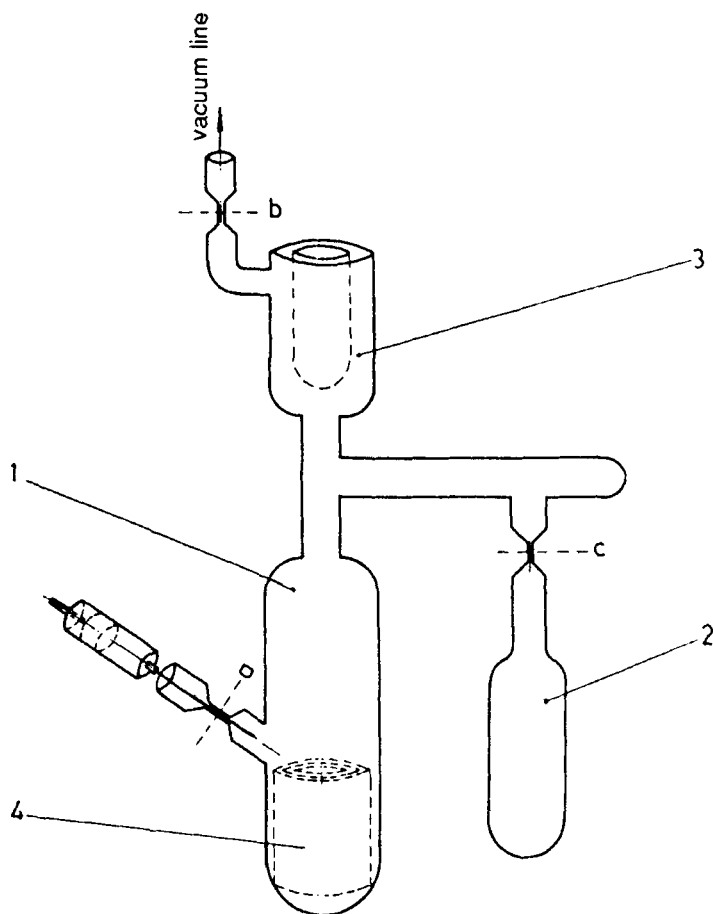

FIG. 2. Apparatus used for phase composition analysis.

direct introduction into the gel. The same results have been obtained independently of the mode of addition. The N_3 spin probe was introduced only in the preformed gel phase.

The copper compound $CuCl_2 \cdot 2H_2O$ (Analar), dehydrated at $150^\circ C$ for 3 h before use, and CuX_2 [where X denotes: 1-methyl-2-carbethoxy-glyoxal-*p*-tolylanil-(1)-*m*-tolylhydrazone-2] were added as solid compounds to the samples containing the spin probes.

The ESR spectra were recorded at room temperature on a JES-3B (JEOL) spectrometer, with 100-kHz field modulation in the X-band frequency. Precautions regarding the microwave power, as well as field modulation amplitude, have been taken in order to avoid line-broadening artifacts. The nitrogen hyperfine splitting (a_N) of ESR spectra was measured by comparison with that of the Fermi's salt parameter ($a_N = 13.0$ G).

The rotational correlation time T_c was calculated according to the following equation [12]:

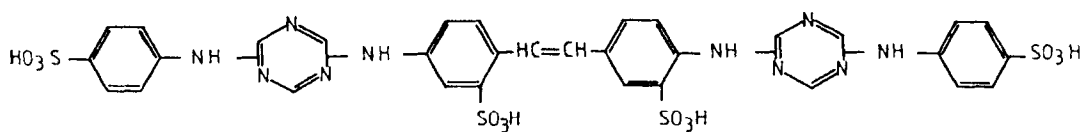

SCHEME 1.

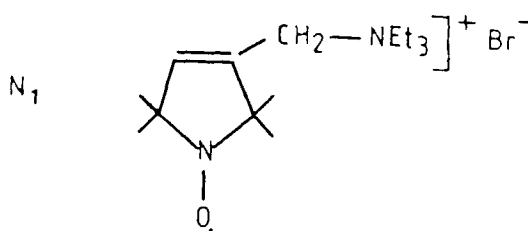

SCHEME 2.

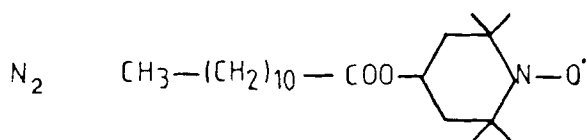

SCHEME 3.

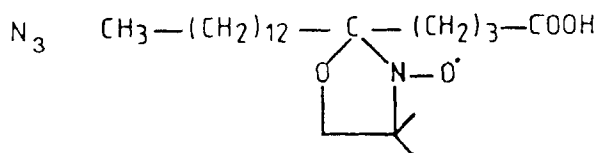

SCHEME 4.

$$T_c = 6.5 H_0 [(h_0/h_{-1})^{1/2} + (h_0/h_{+1})^{1/2} - 2] \times 10^{-10} \text{ s}$$

where h_0 , h_{-1} , h_{+1} are the heights of the central, high-field, and low-field nitrogen lines, respectively (as measured on the first derivative spectra), and H_0 is the line width (peak to peak, in gauss) of the central line.

Viscosimetric measurements were performed using a RN-211 (MLW) rotational viscometer at 25°.

Scanning electron microscopy (SEM) was used to examine polymer samples prepared as follows: Polymerization of acrylamide (contained in gel layers 0.5–1 mm wide and having a composition identical to that normally used for polymerization in inverse suspension) was carried out [9]. The organic phase was expelled from the gel during polymerization and separated before the final gel was removed. A quasi-complete water removal was performed by free evaporation at 25°C over a long period of time (over 10 days). Micrographs were obtained on samples sputter-coated with gold utilizing a Jeol 200C electron microscope.

Cryo scanning electron microscopy. A CT 15500 Cryotrans (Oxford) was interfaced with a Cambridge 120S SEM. A drop of gel was placed on a stub and plunged into nitrogen slush. The frozen gel drop was then positioned on a nitrogen-cooled stage in the preparation chamber, where it was fractured, etched under vacuum, and sputter-coated with gold. The sample was transferred via the Cryotrans unit to the SEM for observation at –170°C.

RESULTS AND DISCUSSION

Characterization of the Acrylamide Gels

Stability of the Gels

When left for a period of time, the acrylamide gels separate into two phases, an organic and an aqueous phase, both being totally transparent. The time required to reach complete separation varies from several hours to several days. This is a function of emulsifier concentration in the organic phase (O), acrylamide concentration in the aqueous phase (W), and O/W ratios. An increase in volume of the separated aqueous phase (W_e) has been noticed in all cases in which the acrylamide concentration of initial aqueous phase (W_i) was greater than 30%. The difference between the initial volume of the aqueous phase (V_{wi}) and the resulting volume after separation (V_{we}) depends on the gel composition, EO(4)NP concentration, acrylamide concentration, the W_i/O_i ratio, and the nature and concentration of the electrolyte. The gel phase may again re-form after mixing of the two separated phases, but after a second separation, the volume of the aqueous phase is no longer modified. Moreover, the volume of W_e remains constant, regardless of the number of mixing-separation cycles. This clearly shows that after the first separation, the system has already reached the equilibrium distribution of all components. After mixing of the aqueous phase obtained after separation (W_e) with pure cyclohexane, gel formation occurs again. But mixing of the separated organic phase (O_e) with an acrylamide solution having the same volume and concentration as the initial aque-

ous phase, W_i , does not result in gel formation, regardless of the mixing time or the stirring intensity. These simple experiments suggest that after gel formation and its separation into two phases, W_e and O_e , an equilibrium has been reached; part of the emulsifier and a certain amount of cyclohexane migrate from O to W . This conclusion has been confirmed by the results on the composition of the two phases after separation. For a wide range of gel compositions, from 67% to 92% of the total amount of emulsifier migrates from O to W .

The results of analysis regarding the composition of W_e and O_e after gel separation are presented in Table 1. The initial formula for the gel phase is identical to that usually used for suspension polymerization, namely:

$$W/(W + O) = 0.25; AM/W = 1/1; EO(4)NP/O = 3\%$$

After gel separation, the aqueous phase is, in fact, a micellar solution of EO(4)NP in the water/acrylamide mixture, as will be shown later.

Conductometric Measurements

In all cases, the transition from the unstable dispersion stage to the gel stage is accompanied by a sharp increase in electrical conductivity, as illustrated in Fig. 3.

This behavior indicates that the gel formation is the result of the conversion of the aqueous phase from a discontinuous phase to a continuous one. The linear increase of the conductivity in the gel phase with the increase of the $W/(W + O)$ ratio provides further evidence (see Fig. 4).

The existence of the aqueous phase as a continuous phase is also supported by the viscoelastic behavior of the gel, noticed during polymerization (Weissenberg effect).

UV-VIS Measurements

The above-mentioned data do not provide any hints about the structure of the organic phase present in gel. Therefore, experiments were carried out concerning diffusion in the gel of certain substances that are soluble in either the O or W phases.

The diffusion studies were performed by UV-VIS spectrometry.

The absorption spectrum of a gel sample having a composition identical to that used in inverse suspension polymerization is presented in Fig. 5. A useful

TABLE 1. Composition of the Aqueous and Organic Phase Prior to Mixing (W_i , O_i) and Subsequent to Gel Separation (W_e , O_e)

	W_i	O_i	W_e	O_e
Water (%)	50	0	44.3	Traces
Acrylamide (%)	50	0	44.2	Traces
Cyclohexane (%)	0	97	5	99.1
EO(4)NP	0	3	6.5	0.6

$$W_i/(W_i + O_i) = 0.25 \text{ (w/w)}; W_e/(W_e + O_e) = 0.28.$$

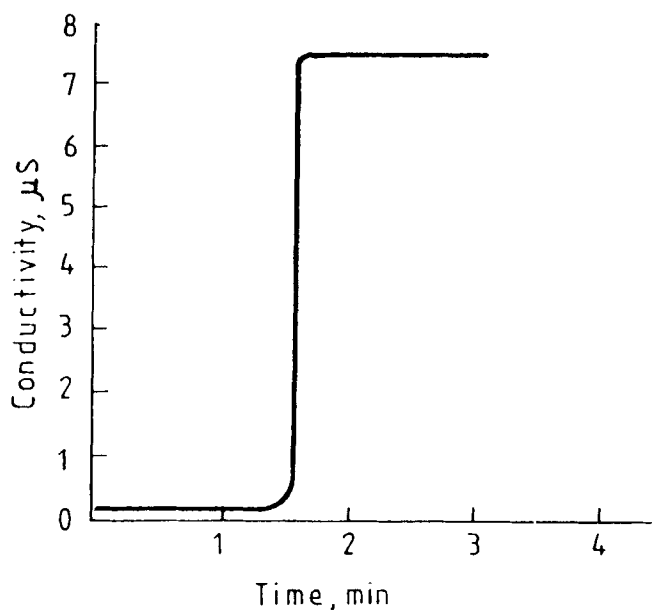

FIG. 3. Variation of electrical conductivity of reaction mixture associated with gel formation; the formula used was the same as in Fig. 2.

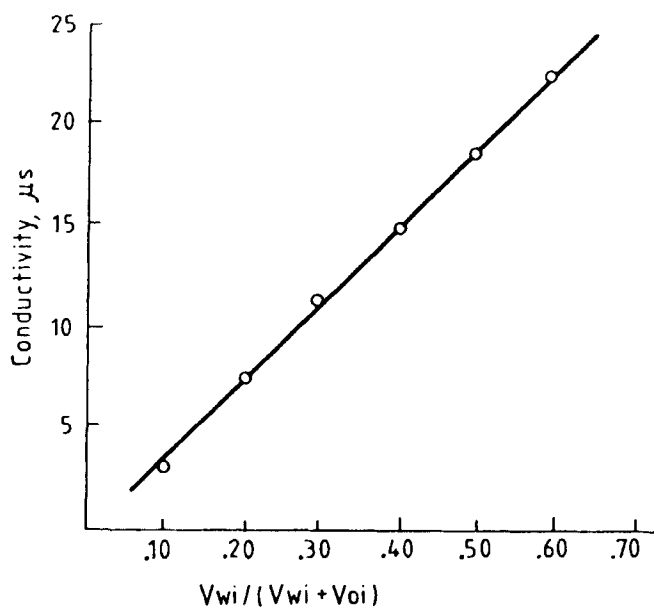

FIG. 4. Variation of electrical conductivity of the gel vs. volume ratio of the phases; $W_i = 1/1$ water/AM; $O_i = 3\%$ EO(4)NP in cyclohexane.

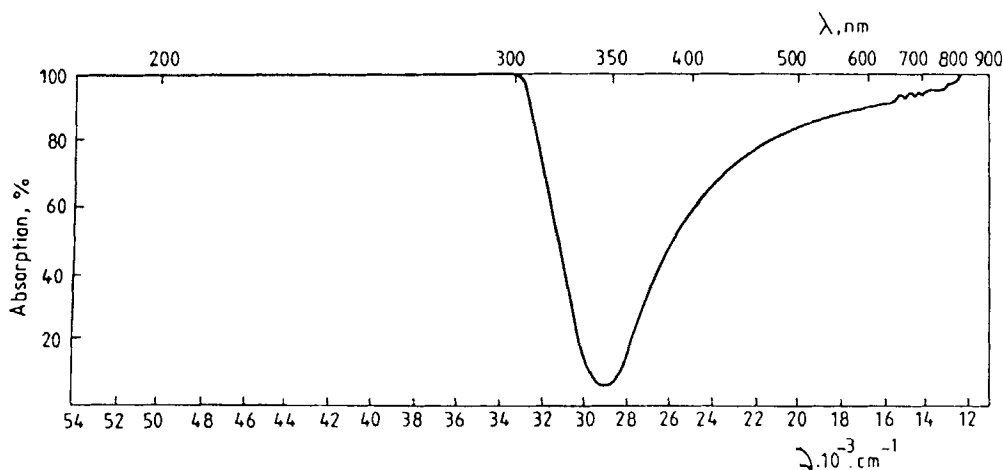

FIG. 5. UV-VIS spectrum of the gel; the formula used was the same as in Fig. 2.

feature of the UV spectra is the existence of a "window" within 300–400 nm where the gel does not absorb.

In this set of experiments, substances that absorb within this range were employed. Anthracene, soluble in *O* and insoluble in *W*, exhibits an intense narrow peak at 373 nm. Stralex, an optical bleacher, soluble in *W* and insoluble in *O*, possesses a strong absorption maximum at 350 nm (in DDI water). When Stralex was dissolved in the aqueous phase, as resulted after the gel phase separation, having the composition presented in Table 1, the absorption maximum was shifted to 375 nm. Therefore, we studied the diffusion into the gel of such markers that are either soluble only in the aqueous phase or only in the organic phase. Diffusion can take place only for the substances that are soluble in the continuous phase. According to the data in Fig. 6 at comparable time intervals, only Stralex was diffusing into aqueous phase. The intensity of the Stralex absorption band increased rapidly in the first 15 min, while in the case of anthracene, even after 4 h a specific absorption could not be detected.

Hence only the water-soluble marker diffused reasonably fast into the gel, proving that the aqueous phase is the continuous phase containing the dispersed organic phase.

The above results support the idea that gel formation occurs following a phase inversion.

ESR Measurements

To obtain information on the phase structure of the gel, two nitroxides, namely a very hydrophilic N_1 and a hydrophobic N_2 , were selected as spin probes. They were introduced into samples of the gels [$W/(W + O) = 0.10$ and 0.20], as previously described in the experimental section.

N_1 presents the same unique spectrum for both compositions investigated. For the same gels, the spectra of radical N_2 show asymmetrical lines, an indication of overlapping spectra, corresponding to the location of the spin probe in at least two

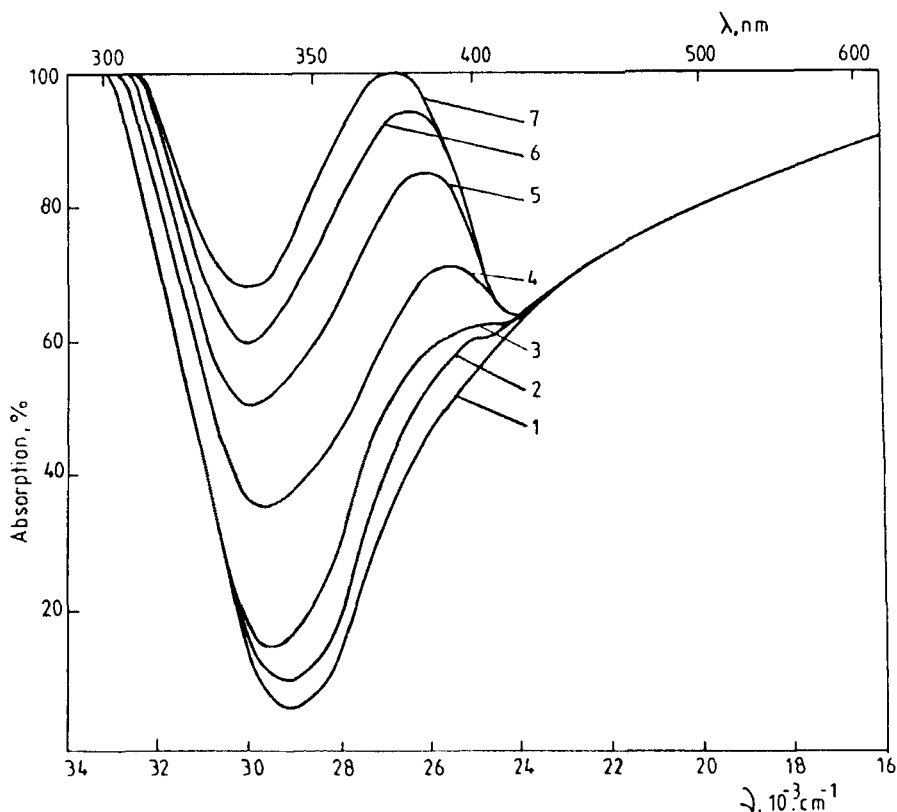

FIG. 6. Changes in UV-VIS spectra of the gel vs. diffusion time of Stralex (see Experimental section); (1) 0 min; (2) 2 min; (3) 4 min; (4) 7 min; (5) 10 min; (6) 13 min; (7) 15 min.

media. The exchange rate of the radical between them is slow on the ESR time scale ($\mathcal{J}_{ex} < 10^6 \text{ s}^{-1}$).

Addition of CuCl_2 , a paramagnetic salt that selectively broadens out the spectral lines of nitroxides in aqueous phase [13], leaves a unique spectrum. The parameters of the ESR spectra, i.e., the nitrogen hyperfine splitting a_N and the rotational correlation time T_c , are given in Table 2.

For comparison, in the same table, the ESR parameters of N_1 and N_2 in other media [water, 1/1 water/acrylamide mixture, cyclohexane and 3% EO(4)NP in cyclohexane] are also given. The data show that for the N_1 spin probe the gel spectrum parameters are the same as those of the 1/1 water/acrylamide mixture, whereas for N_2 , the spectrum left after "quenching" (with CuCl_2) has the same features as its spectrum in cyclohexane or in 2.8% EO(4)NP solution in cyclohexane.

The third spin probe, 5-doxyl stearic acid (N_3), was introduced in the gels to show the anisotropic motion in ordered layers at interfaces [14, 15]. In this case, overlapped spectra have been noticed. After addition of an oil-soluble copper complex (CuX_2), which selectively broadens out the organic phase spectrum, an anisotropic spectrum was recorded (see Fig. 7).

TABLE 2. Parameters of ESR Spectra of Nitroxides N_1 and N_2 in the Mentioned Systems

System	N_1		N_2	
	$a_N(G)$	$T_c(10^{-10} \text{ s})$	$a_N(G)$	$T_c(10^{-10} \text{ s})$
Water	15.9	0.6	16.8	1.0
1/1 water/AM	15.6	1.0	16.7	1.5
Gel (10%) ^a	15.6	1.2	15.3	0.4 ^d
Gel (20%) ^b	15.5	1.3	15.3	0.4 ^d
Cyclohexane	—	—	15.3	0.3
2.8% of EO(4)NP in cyclohexane	—	—	15.3	0.3
Phases separated out of the 20% gel				
Organic phase	^c	^c	15.3	0.3
Aqueous phase	15.5	1.0	16.2	3.9

^a $W_i/(W_i + O_i) = 0.1$; $W_i = 1/1$ water/AM; $O_i = 4.3\%$ EO(4)NP in cyclohexane.

^b $W_i/(W_i + O_i) = 0.2$; W_i and O_i are the same as at ^a.

^cNo spectra observed.

^dSpectra measured in the presence of CuCl_2 .

This fact proves the existence of an interface where the surfactant is incorporated with its polar heads in the aqueous phase and the hydrophobic tails form a relatively ordered layer. A similar spectrum was observed with the same spin probe N_3 in a middle-phase microemulsion as reported in Ref. [15].

In conclusion, the ESR spectra reveal the coexistence of two phases, water/acrylamide and cyclohexane, separated by an interface where the surfactant and possibly acrylamide as cosurfactant is incorporated. In both phases, the motion of the spin probes is unrestrained, which differs significantly from micelles [16]. One can infer that the dimensions of both phases present in the gel are larger than those of micellar aggregates. This conclusion is also supported by the electron microscopy studies, as will be discussed in the next section.

After complete separation of the gels into two macroscopic phases, the above-mentioned nitroxides were introduced into samples of each phase. The results are presented in Table 2 and show that N_1 is completely insoluble in the organic phase, which points to the absence of reversed micelles. This had been noticed in separate experiments in the EO(4)NP/cyclohexane/water systems [17]. Therefore, most of the surfactant had already left the cyclohexane phase. The spectrum of N_1 in the aqueous phase corresponds to that recorded in the 1/1 water/acrylamide mixture.

The nitroxide N_2 dissolved in the organic phase exhibits a cyclohexane-like spectrum, as expected, but in the separated aqueous phase its correlation time is significantly higher (10 times), which clearly indicates that the radical is included in micellar aggregates. These must be EO(4)NP micelles in the 1/1 water/acrylamide mixture. These results show that the continuous phase in which the polymerization

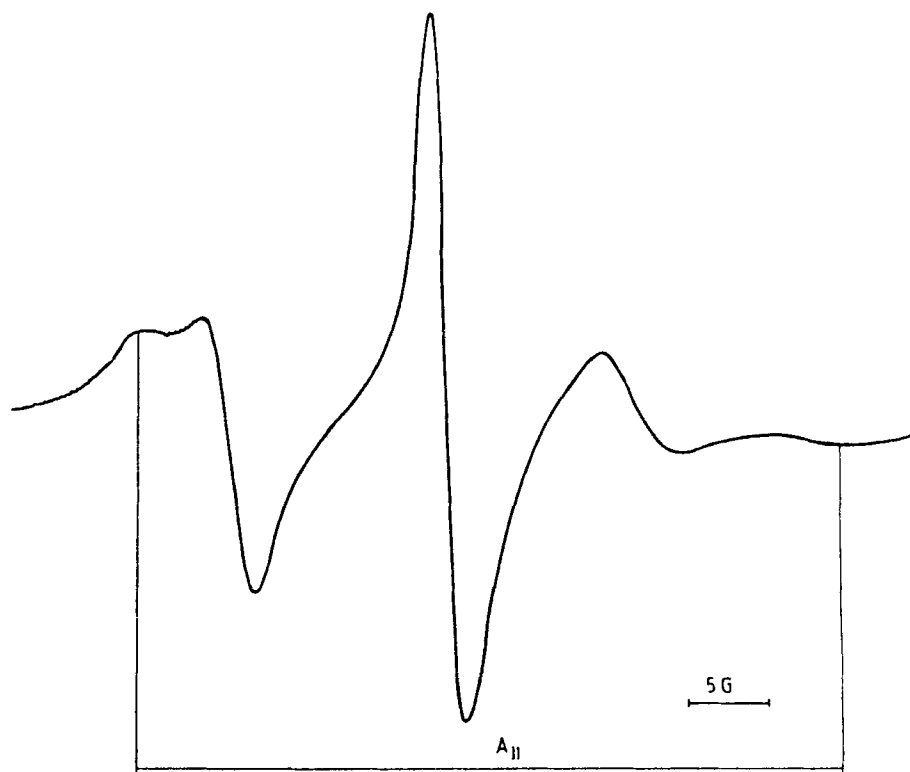

FIG. 7. ESR spectrum of 5-doxyl stearic acid (N_3) in gel [$W_i/(W_i + O_i) = 0.1$] after addition of CuX_2 . (A) The parallel component of nitrogen hyperfine splitting tensor. $W_i = 1/1$ water/AM; $O_i = 3\%$ EO(4)NP in cyclohexane.

takes place represents an oil-in-water-type microemulsion. They also constitute another proof of surfactant transfer from the organic to the aqueous phase.

Electron Microscopy

In Fig. 8, the electron micrographs obtained by freeze-fracture and cold-stage SEM observation of the gel phase show a discontinuous structure corresponding to a concentrated oil-in-water emulsion. The aqueous phase in the gel represents the continuous phase that forms the walls of the "sponge," while the organic phase exists in discrete dispersed domains as inclusions. The observed gel phase structure correlates well with the former results obtained by conductometric measurements or diffusion of UV markers into the gel.

All the above results proved that the gel formation results as a phase inversion of the system, and its structure represents a concentrated oil-in-water emulsion. The polymerization takes place in the continuous phase, which itself represents an oil-in-water microemulsion, as demonstrated by ESR measurements and the composition analyses of the separated aqueous phase.

Figure 9 shows electron micrographs of polyacrylamide samples prepared by polymerization of the acrylamide gel phase in thin layers (0.5–1 mm thickness).

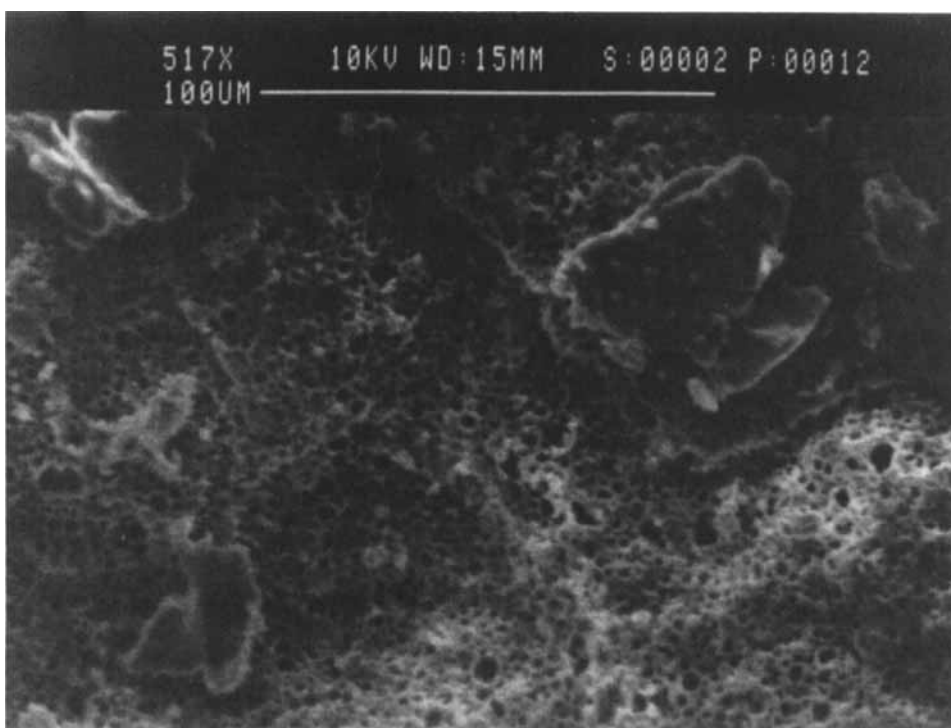

FIG. 8. SEM micrograph of the gel phase obtained by freeze-fracture.

Comparison of the morphologies in Figs. 8, 9, and 10 shows that the gel structure was not preserved during polymerization. The aqueous phase in which the polymerization takes place shrank and expelled the organic phase. During the shrinking-expelling process, the aqueous continuous phase collapsed and fused. In the meantime, the organic phase domains coalesced and were expelled, and the whole system changed, shifting the discontinuous structure of the acrylamide gel phase before polymerization to a bicontinuous phase system (interpenetrating network) in the early stages of the polymerization. Under stirring (after reaching a particular conversion) and due to the fact that most of the emulsifier had already transferred into the aqueous phase, the gel disintegrated into 0.2- to 1-mm particles. The polymerization then took place up to complete conversion in the resulting fragments, which constitute the final polyacrylamide beads. Figure 10 is a SEM micrograph of a polyacrylamide bead resulting in the inverse suspension polymerization.

The Influence of Electrolytes on the Molecular Weight of Polyacrylamide

In our previous paper [9], we demonstrated the existence of chain transfer reactions with the emulsifier in the inverse suspension polymerization of acrylamide. It was also reported that the presence of sodium salts of organic acids produced a significant increase in the molecular weight of polyacrylamide. In all systems studied and for a relatively broad range of Na organic acid salt concentrations (Fig. 6 in

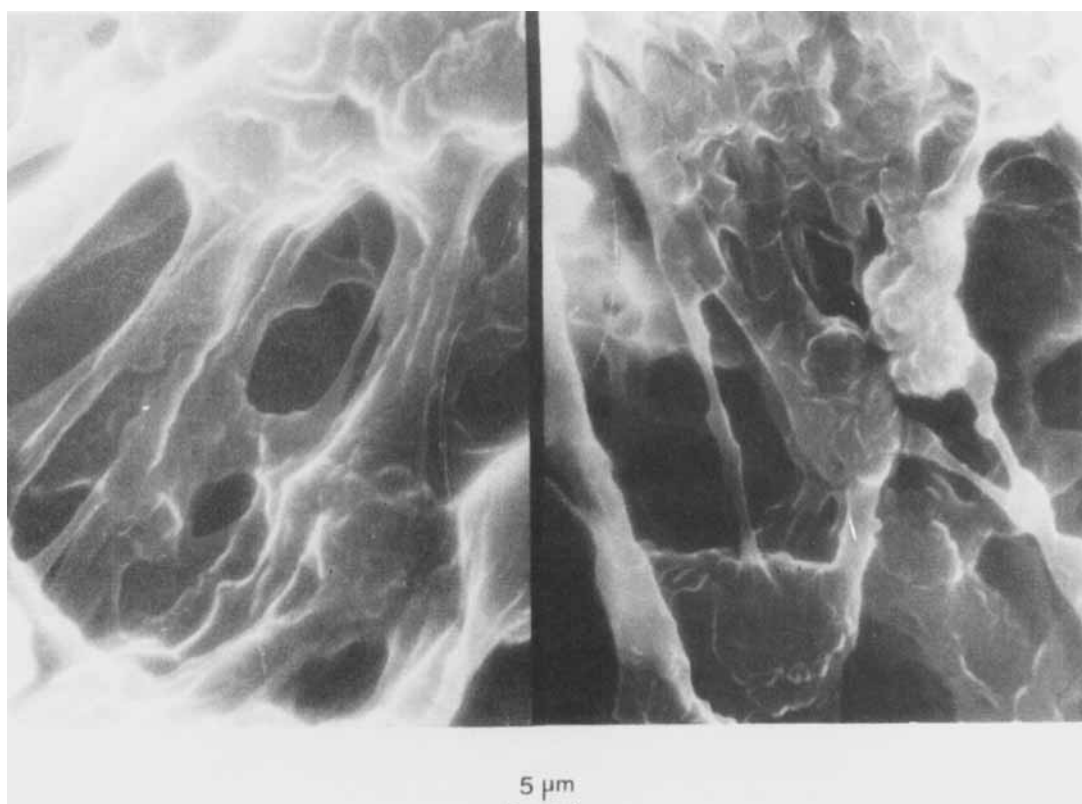

FIG. 9. SEM micrograph of polyacrylamide obtained by acrylamide thin-layer gel polymerization; gel layer thickness ~ 1 mm. The formula used was the same as in Fig. 2.

FIG. 10. SEM micrograph of polyacrylamide bead obtained in inverse suspension polymerization.

Ref. [9]), the continuous increase in molecular weight of polyacrylamide with increasing concentration of the salts supports the idea that these substances can block chain transfer reactions with emulsifier.

As shown earlier in this work, the aqueous phase in which polymerization takes place represents a microemulsion. It is probable that the influence of the organic acids salts on the chain transfer reaction with emulsifier is the result of different factors such as chemical equilibria or "salting in" and "salting out" phenomena of the emulsifier molecules [7]. To obtain more information on the role of alkaline salts of organic acids in the chain transfer reaction with emulsifier, a series was investigated to compare the influence of Li, Na, K, ammonium salts of organic acids and some inorganic salts on the molecular weight of polyacrylamide. The data are presented in Tables 3 and 4 and Fig. 11.

These data may be summarized as follows:

1. Inorganic salts in some cases have no influence, or in others a negative effect, on molecular weight of polyacrylamide.

TABLE 3. Influence of Added Inorganic Salts on the Molecular Weight of Polyacrylamide Obtained by Inverse Suspension Polymerization^a

Salt	$M_v \cdot 10^{-6}$
None	3.2
MgCl ₂	2.5
MgSO ₄	3.6
KCl	2.75
NaCl	1.7
K ₂ SO ₄	1.5
NaNO ₃	3.2

^a $W_i(W_i + O_i) = 0.25$; $W_i = 1/1$ water/AM; $O_i = 3\%$ D EO(4)NP in cyclohexane; K₂S₂O₈ = 8/1 molar ratio; K₂S₂O₈ $v = 7.35 \times 10^{-4} M$ in W_i .

[salt] = $2 \cdot 10^{-2} M$ in W_i .

2. The value of the molecular weight is influenced by the nature of both anion and cation, as in the case of alkaline salts of organic acids.
3. For the same salt and emulsifier content, the molecular weight decreases, with increasing number of ethylene oxide units of the emulsifier.
4. Small quantities of polyethylene glycol (PEG-300) cancel the positive effect of alkaline organic salts.
5. The dependence of polyacrylamide molecular weight on concentration of sodium acetate can be described as a curve with a maximum (see Fig. 11).
6. The ammonium salts of organic acids have no effect on the molecular weight of polyacrylamide produced by inverse suspension polymerization.

Using different ethoxylated emulsifiers (MYRJ-45), the same effect of the alkaline salts of organic acids on the polyacrylamide molecular weight was observed.

The data concerning the influence of electrolytes and emulsifier concentration on the polymerization of acrylamide in a heterogeneous media are often contradictory [1, 2, 7]. Such discrepancies are probably due to the different nature of the emulsifier and initiators used, which directly affects the topochemistry of the process and/or the intensity of the chain transfer reaction.

It has been shown [9] that the decrease in molecular weight of polyacrylamide obtained by polymerization in inverse suspension with increase in the emulsifier concentration is due to chain transfer reaction. The transfer reaction probably takes place on the polyethylene oxide chains present in EO(4)NP, very likely on a methylene group activated by the proximity of an ether oxygen [18]. The ability of polyethylene glycol to complex with alkali metal ions by ion-dipole interaction is also well known [19] (Scheme 5).

In such a complex, the activating capacity of ether oxygen is greatly diminished, which results in a decrease of chain transfer reactions. This hypothesis is

TABLE 4. Influence of Added Organic Salts on the Molecular Weight of the Polyacrylamide Obtained by Inverse Suspension Polymerization^a

Emulsifier	Salt		[salt] mole/L in W_i	PEG-300 in W_i g/L	$M_v \times 10^{-6}$
	Anion	Cation			
EO(4)NP	CH_3COO^-	Li^+	2×10^{-2}	—	10.2
	CH_3COO^-	Na^+	2×10^{-2}	—	8.6
	CH_3COO^-	Na^+	2×10^{-2}	4×10^{-3}	2.9
	CH_3COO^-	K^+	2×10^{-2}	—	8.1
	CH_3COO^-	K^+	2×10^{-2}	4×10^{-3}	3.2
	CH_3COO^-	NH_4^+	2×10^{-2}	—	3.2
	$\text{CH}_3\text{CH}_2\text{COO}^-$	Na^+	2×10^{-2}	—	10.3
	$\text{CH}_3\text{CH}_2\text{COO}^-$	K^+	2×10^{-2}	—	9.1
	$\text{CH}_3(\text{CH}_2)_{16}\text{COO}^-$	Na^+	5×10^{-3}	—	9.8
Stearine ^b ethoxylated (8EO)	CH_3COO^-	Li^+	2×10^{-2}	—	8.1
	CH_3COO^-	Na^+	2×10^{-2}	—	7.2
	CH_3COO^-	Na^+	2×10^{-2}	4×10^{-3}	3.05
	$\text{CH}_3\text{CH}_2\text{COO}^-$	Na^+	2×10^{-2}	—	8.1
	$\text{CH}_3\text{CH}_2\text{COO}^-$	K^+	2×10^{-2}	—	8.6
	$\text{CH}_3\text{CH}_2\text{COO}^-$	K^-	2×10^{-2}	4×10^{-3}	2.8

^aThe formula used was the same as in Table 3.

^b3% in cyclohexane.

supported by the apparent lack of activity of ammonium salts of organic acids when present in acrylamide polymerization. A possible explanation is that ammonium ions fail to form such complexes.

Annihilation of the action of organic acid salts (they usually determine an increase of molecular weight of acrylamide) by introduction of small amounts of PEG-300 is probably due to the fact that the latter forms complexes with alkali metal cations much more efficiently than the ethylene oxide chain of EO(4)NP. In this case, the EO(4)NP turns again into a chain transfer agent.

The electrolyte effect in inverse suspension polymerization of acrylamide can be compared to the electrolytes' influence on the solution behavior of ethoxylated surfactants. The "cloud point" of their aqueous solutions (the phase separation occurring when heated due to polyethylene oxide chain dehydration) is influenced by the presence and nature of electrolytes. Some electrolytes produce a decrease in the cloud point by dehydration of polyethylene oxide chains, which generates a decrease in salt concentration surrounding the polyethylene oxide chains—the "salting-out effect." On the contrary, other type of electrolytes induce an increase in the cloud point by increasing the hydration of ethylene oxide chains as a consequence of higher local salt concentration created around polymer chains—the

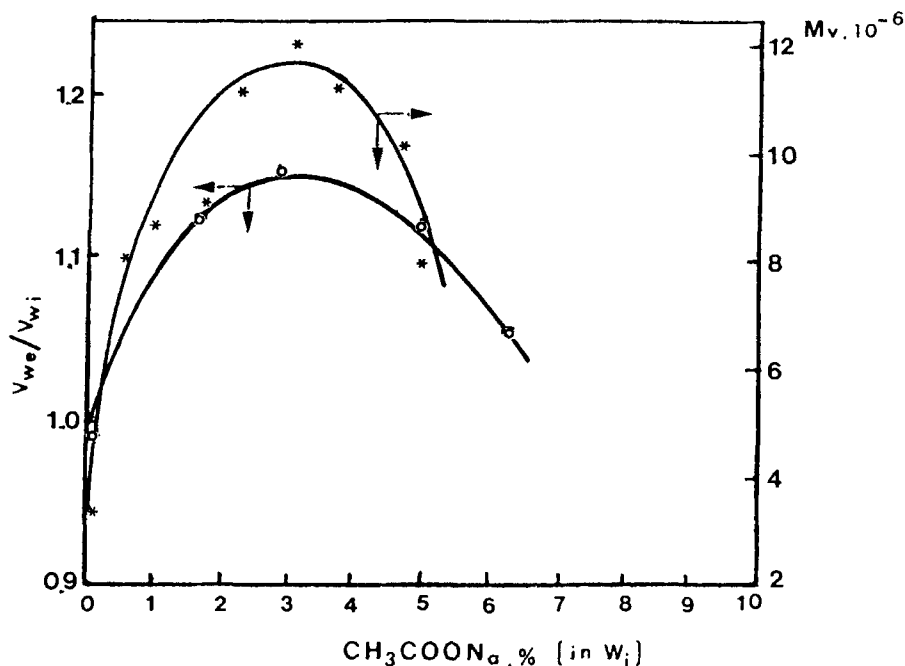
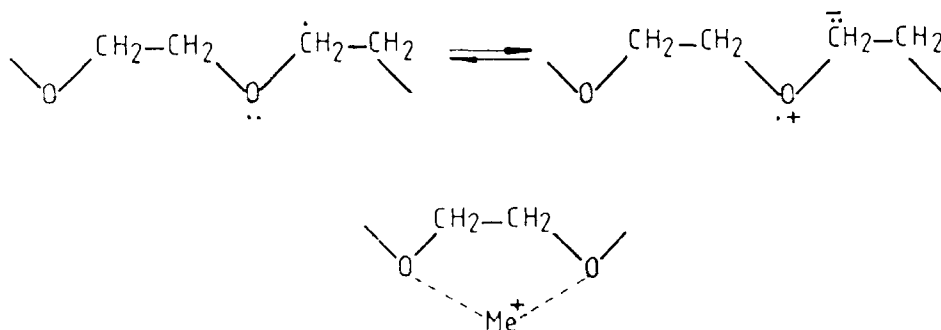

FIG. 11. Influence of sodium acetate concentration on the molecular weight of polyacrylamide and gel phase separation.

“salting-in effect.” Although these phenomena are not fully understood, a widely accepted explanation for them is based on the changes in the water structure surrounding the electrolyte ions. Because of these changes, the water-emulsifier interactions are also affected.

The role of the organic anion probably is related to the increase in total salt concentration at the interface.

Regarding the influence of sodium acetate on molecular weight of polyacrylamide and on gel phase separation, one can observe that the molecular weight of polyacrylamide and the value of the ratio V_{we}/V_{wi} reaches a maximum for the same concentration of sodium acetate (3% CH_3COONa), as shown in Fig. 11.



SCHEME 5.

Up to a concentration of 3%, sodium acetate favors the migration of organic phase components into the aqueous phase. The further increase in concentration of sodium acetate has an opposite effect. This behavior is similar to that noticed by Candau and co-workers [20], who studied acrylamide microemulsions. Very likely the same explanation may be given in our case.

At low concentration of sodium acetate, the salting-in effect is prevailing due to the formation of acrylamide-Na complexes [21] as well as the solvation of emulsifier by water molecules. On the contrary, at higher concentrations of sodium acetate, the salting-out effect is prevailing (desolvation of the emulsifier molecules), which is typical for this electrolyte.

Due to the strong salting-out effect, inherent to most inorganic anions, their local concentration at the interface is low, and their action of hindering chain transfer reactions with the emulsifier is practically nonexistent.

CONCLUSIONS

The inverse suspension polymerization of acrylamide was carried out by dispersing the concentrated solution of acrylamide in cyclohexane containing ethoxylated nonylphenol ethers [EO(4)NP] and using a redox initiator ($\text{NaHSO}_3\text{-K}_2\text{S}_2\text{O}_8$).

Even for the early stages of the polymerization, a phase inversion occurred. The topochemistry changes during the reaction show several distinct stages: coarse water-in-oil dispersion, concentrated oil-in-water emulsion, bicontinuous system, and coarse polymer/water dispersion in oil. The main reaction, which determines the limitation of the molecular weight, is the chain transfer reaction with the emulsifier EO(4)NP.

The alkali metal salts of organic acids may block the transfer reaction by producing a high local electrolyte concentration at the interface and forming complexes with the ethylene oxide units of the emulsifier chain.

ACKNOWLEDGMENTS

The authors are indebted to Dr. Ileana Dragutan for a generous gift of the spin probes N_2 and N_3 .

REFERENCES

- [1] W. Baade and K. H. Reichert, *Eur. Polym. J.*, **10**, 505 (1984).
- [2] J. W. Vanderhoff, F. V. Di Stefano, M. S. El-Aasser, R. O'Leary, O. Shaffer, and D. S. Visioli, *J. Dispers. Sci. Technol.*, **5**, 323 (1984).
- [3] G. Pichot, C. Graillat, and V. Glukhikh, *Macromol. Chem.*, Vol. **10/11**(suppl.), 199 (1985).
- [4] V. F. Gromov, T. O. Osmanov, I. V. Glazkova, I. A. Gritskova, and E. J. Teleshov, *Visokomol. Soed. A XXX*, (6), 1164 (1988).
- [5] K. J. Kim and E. Ruckenstein, *Macromol. Chem. Rapid Commun.*, **9**, 285 (1988).

- [6] C. Graillat, C. Pichot, A. Guyot, and M. S. El-Aasser, *J. Polym. Sci., Polym. Chem. Ed.*, **24**, 427 (1986).
- [7] F. Candau, Y. S. Leong, G. Pouyet, and S. J. Candau, *J. Colloid Interface Sci.*, **101**, 167 (1984).
- [8] C. Holtzschere, J. P. Durand, and F. Candau, *Colloid Polymer Sci.*, **265**, 1067 (1987).
- [9] M. V. Dimonie, C. M. Boghina, N. M. Marinescu, M. M. Marinescu, C. I. Cincu, and C. G. Oprescu, *Eur. Polym. J.*, **18**, 639 (1982).
- [10] C. M. Boghina, C. I. Cincu, N. M. Marinescu, M. M. Marinescu, M. V. Dimonie, M. Lecca, and G. Popescu, *J. Macromol. Sci.—Chem.*, **A22(5)**, 591 (1985).
- [11] H. Caldararu, A. Carageorgheopol, A. Caldararu, M. Dimonie, D. Donescu, I. Dragutan, and N. Marinescu, *Rev. Roumaine Chim.*, **35(7)**, 853 (1990).
- [12] T. J. Stone, T. Buckman, P. L. Nordio, and M. M. McConnell, *Proc. Natl. Acad. Sci. USA*, **54**, 1010 (1965).
- [13] J. S. Hyde, H. M. Swartz, and W. E. Antoline, in *Spin Labeling II* (L. J. Berliner, ed.), Academic Press, New York, San Francisco, London, 1988, p. 71.
- [14] J. Seeling, in *Spin Labeling* (L. J. Berliner, ed.), Academic Press, New York, San Francisco, London, 1976, p. 374.
- [15] C. Ramachandran, S. Vijayan, and D. O. Shah, *J. Phys. Chem.*, **84**, 1561 (1988).
- [16] J. H. Fendler and E. J. Fendler, *Catalysis in Micellar and Macromolecular Systems*, Academic Press, New York, San Francisco, London, 1975, p. 68.
- [17] A. Carageorgheopol, H. Caldararu, M. V. Dimonie, D. Donescu, I. Dragutan, and N. M. Marinescu, in *Proc. IIIrd Symposium in Colloid and Surface Chemistry*, Timisoara, Romania, 1989, p. 25.
- [18] D. C. Nonhebel and J. C. Walton, in *Himia Svobodnih Radicalov*, Izdatelstvo Mir, Moscow, 1977, p. 117.
- [19] H. J. Buschmann, *Macromol. Chem.*, **187(2)**, 423 (1986).
- [20] C. Holzschere and F. Candau, *J. Colloid Interface Sci.*, **125**, 97 (1988).
- [21] V. F. Gromov, T. O. Osmanov, P. M. Khomikovskii, and A. D. Abkin, *Eur. Polym. J.*, **16**, 803 (1980).

Received February 22, 1991

Revision received August 21, 1991